

MVE Freezer Inventory Systems

Square Racks / Vial Boxes / Blood Bag Frames / Blood Bag Cassettes



BioMedical

Standard Square Racks

with locking rod

Large Square Rack Mini Square Rack

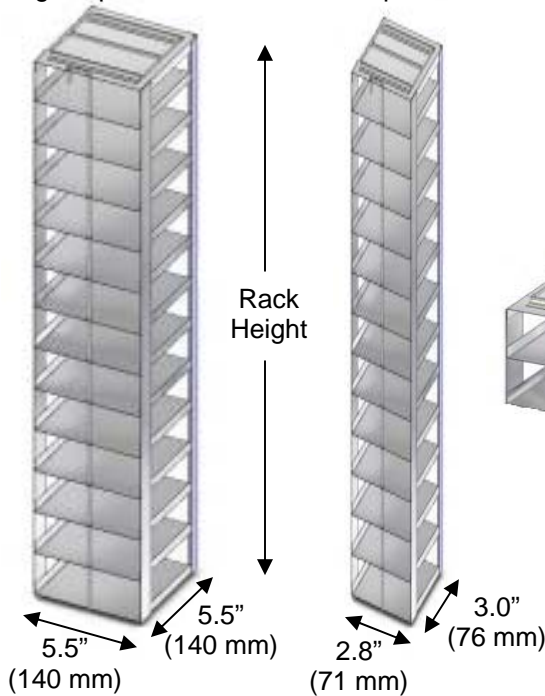

Standard Shelf Heights

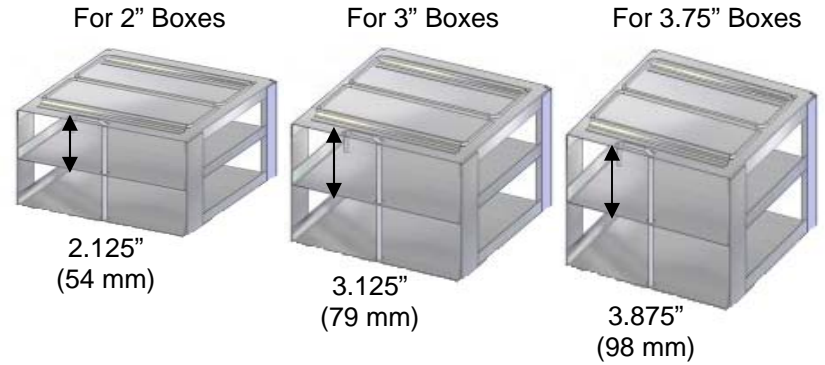

2" Box Large Racks

Part Number Stainless Steel (24 gauge)	Part Number Aluminum (20 gauge)	Description (5.5" x 5.5") (140 mm x 140 mm)	Rack Height (approximate) Inches (mm)
11831871	11831862	15 shelf large rack	32.50 (825)
11831791	11831774	14 shelf large rack	30.25 (768)
10544431	10544440	13 shelf large rack	28.25 (718)
10544415	10544423	12 shelf large rack	26.25 (667)
10544394	10544407	11 shelf large rack	24.00 (610)
10544378	10544386	10 shelf large rack	21.75 (552)
10544351	10544360	9 shelf large rack	19.50 (495)
10544319	10544327	8 shelf large rack	17.50 (445)
10544271	10544280	7 shelf large rack	15.25 (388)
10544239	10544247	6 shelf large rack	13.25 (337)
10557646	n/a	5 shelf large rack	12.00 (305)

2" Box Mini Racks

Part Number Stainless Steel (24 gauge)	Part Number Aluminum (20 gauge)	Description (3.0" x 2.8") (76 mm x 71 mm)	Rack Height (approximate) Inches (mm)
11831897	11831862	15 shelf mini rack	32.50 (825)
11831811	11831803	14 shelf mini rack	30.25 (768)
10544685	10544693	13 shelf mini rack	28.25 (718)
10544669	10544677	12 shelf mini rack	26.25 (667)
10544642	10544651	11 shelf mini rack	24.00 (610)
10544626	10544634	10 shelf mini rack	21.75 (552)
10544600	10544618	9 shelf mini rack	19.50 (495)
10544562	10544571	8 shelf mini rack	17.50 (445)
10544520	10544538	7 shelf mini rack	15.25 (388)
10544482	10544491	6 shelf mini rack	13.25 (337)

3" Box Large Racks

Part Number Stainless Steel (24 gauge)	Part Number Aluminum (20 gauge)	Description (5.5" x 5.5") (140 mm x 140 mm)	Rack Height (approximate) Inches (mm)
11831918	11831900	11 shelf large rack	35.00 (890)
11831838	11831820	9 shelf large rack	28.75 (724)
10544335	10544343	8 shelf large rack	24.75 (629)
10544298	10544301	7 shelf large rack	21.75 (553)
10544255	10544263	6 shelf large rack	18.75 (478)
10544212	10544221	5 shelf large rack	15.75 (400)
10583035	10621185	4 shelf large rack	12.50 (317)

3" Box Mini Racks

Part Number Stainless Steel (24 gauge)	Part Number Aluminum (20 gauge)	Description (3.0" x 2.8") (76 mm x 71 mm)	Rack Height (approximate) Inches (mm)
11831934	11831926	11 shelf mini rack	35.00 (890)
11831854	11831846	9 shelf mini rack	28.75 (724)
10544589	10544597	8 shelf mini rack	24.75 (629)
10544546	10544554	7 shelf mini rack	21.75 (553)
10544503	10544511	6 shelf mini rack	18.75 (478)
10544466	10544474	5 shelf mini rack	15.75 (400)
10583043	10621193	4 shelf mini rack	12.50 (317)

3.75" Box Large Racks

Part Number Stainless Steel (24 gauge)	Part Number Aluminum (20 gauge)	Description (5.5" x 5.5") (140 mm x 140 mm)	Rack Height (approximate) Inches (mm)
11688138	11684698	7 shelf large rack	26.75 (680)
13166843	n/a	6 shelf large rack	23.00 (584)
10545389	10545397	5 shelf large rack	19.25 (489)
10545346	10545354	4 shelf large rack	15.50 (394)
n/a	11938862	3 shelf large rack	11.75 (299)

3.75" Box Mini Racks

Part Number Stainless Steel (24 gauge)	Part Number Aluminum (20 gauge)	Description (3.0" x 2.8") (76 mm x 71 mm)	Rack Height (approximate) Inches (mm)
10545400	10545418	5 shelf mini rack	19.25 (489)
10545362	10545371	4 shelf mini rack	15.50 (394)

MVE Vial Storage Boxes

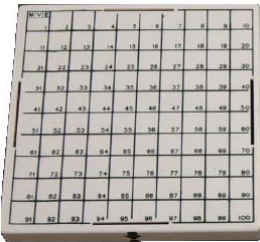
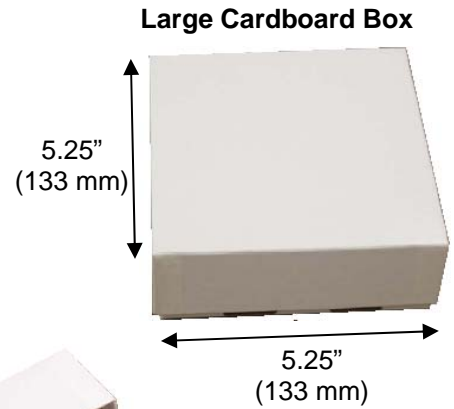
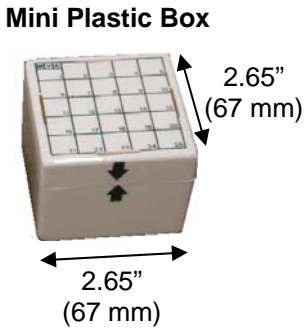
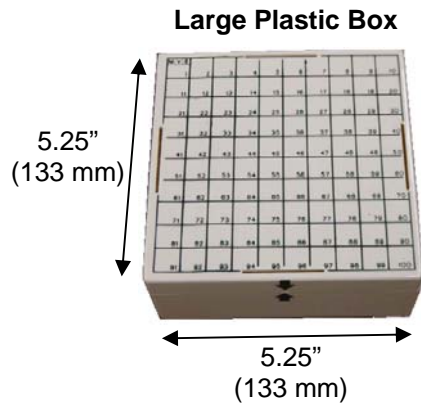

Large Clear Plastic Box

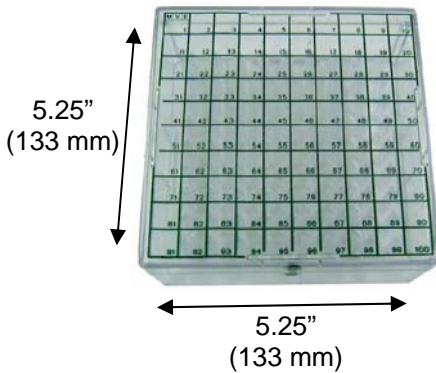

2" Boxes

Material	Description	Part Number	Box Height Inches (mm)
Plastic	Large Box – 100 cell	9719649	2.00 (51)
	Large Clear Box – 100 cell	9719649CLR	2.00 (51)
	Mini Box – 25 cell	9719629	2.00 (51)
Cardboard	Large Box – 81 cell	9714099	2.00 (51)

3" Boxes

Material	Description	Part Number	Box Height Inches (mm)
Plastic	Large Box – 100 cell	9719659	3.00 (76)
	Mini Box – 25 cell	9719639	3.00 (76)
Cardboard	Large Box – 81 cell	9714109	3.00 (76)

3.75" Boxes

Material	Description	Part Number	Box Height Inches (mm)
Plastic	Large Box – 81 cell	10545291	3.75 (95)
	Mini Box – 25 cell	10545282	3.75 (95)
Cardboard	Large Box – 81 cell	10545311	3.75 (95)

NOTE: Plastic box capacities are based on internally threaded vials

Square Rack Inventory Systems
MVE High Efficiency Series (-150 / -190)
Maximum Capacities

Freezer Model	Racks	Number of Racks	Number of Boxes
MVE 815P	12-2 Large	12	144
	12-2 Mini	4	48
	7-3 Large	12	84
	7-3 Mini	4	28
	6-3.75 Large	12	72
MVE 818P	14-2 Large	12	168
	14-2 Mini	4	56
	9-3 Large	12	108
	9-3 Mini	4	36
	7-3.75 Large	12	84
MVE 819P	15-2 Large	12	180
	15-2 Mini	4	60
	9-3 Large	12	108
	9-3 Mini	4	36
	7-3.75 Large	12	84
MVE 1536P	13-2 Large	24	312
	13-2 Mini	16	208
	8-3 Large	24	192
	8-3 Mini	16	128
	7-3.75 Large	24	168
MVE 1539P	14-2 Large	24	336
	14-2 Mini	16	224
	9-3 Large	24	216
	9-3 Mini	16	144
	7-3.75 Large	24	168
MVE 1879P	13-2 Large	54	702
	13-2 Mini	30	390
	8-3 Large	54	432
	8-3 Mini	30	240
	7-3.75 Large	54	378
MVE 1892P	15-2 Large	54	810
	15-2 Mini	30	450
	11-3 Large	54	594
	11-3 Mini	30	330
	7-3.75 Large	54	378
MVE 1539R	13-2 Large	26	338
	13-2 Mini	16	208
	8-3 Large	26	208
	8-3 Mini	16	128
	7-3.75 Large	26	182
MVE 1542R	14-2 Large	26	364
	14-2 Mini	16	224
	9-3 Large	26	234
	9-3 Mini	16	144
	7-3.75 Large	26	182
MVE 1881R	13-2 Large	60	780
	13-2 Mini	12	156
	8-3 Large	60	480
	8-3 Mini	12	96
	7-3.75 Large	60	420
MVE 1894R	15-2 Large	60	900
	15-2 Mini	12	30
	11-3 Large	60	660
	11-3 Mini	12	132
	7-3.75 Large	60	420



Square Rack Inventory Systems

MVE Series

Maximum Capacities

Vapor Phase Storage with Vapor Platform

Freezer Model	Storage Phase	Racks	Number of Racks	Number of Boxes
MVE 204	Liquid	8-2 Large	4	32
		6-3 Large	4	24
		4-3.75 Large	4	16
	Vapor	6-2 Large	4	28
		4-3 Large	4	16
		3-3.75 Large	4	12
MVE 205	Liquid	13-2 Large	4	52
		8-3 Large	4	32
		7-3.75 Large	4	28
	Vapor	10-2 Large	4	40
		7-3 Large	4	28
		6-3.75 Large	4	24
MVE 510	Liquid	13-2 Large	7	91
		13-2 Mini	4	52
		8-3 Large	7	56
		8-3 Mini	4	32
		7-3.75 Large	7	49
	Vapor	11-2 Large	7	77
		11-2 Mini	4	44
		7-3 Large	7	49
		7-3 Mini	4	28
		6-3.75 Large	7	35
MVE 616/616C	Liquid	13-2 Large	12	156
		13-2 Mini	4	52
		8-3 Large	12	96
		8-3 Mini	4	32
		7-3.75 Large	12	84
	Vapor	11-2 Large	12	132
		11-2 Mini	4	44
		7-3 Large	12	84
		7-3 Mini	4	28
		6-3.75 Large	12	72
MVE 1426/1426C	Liquid	13-2 Large	18	234
		13-2 Mini	10	130
		8-3 Large	18	144
		8-3 Mini	10	80
		7-3.75 Large	18	126
	Vapor	11-2 Large	18	198
		11-2 Mini	10	110
		7-3 Large	18	126
		7-3 Mini	10	70
		6-3.75 Large	18	108
MVE 1839	Liquid	13-2 Large	28	364
		13-2 Mini	8	104
		8-3 Large	28	224
		8-3 Mini	8	64
		7-3.75 Large	28	196
	Vapor	12-2 Large	28	336
		12-2 Mini	8	96
		8-3 Large	28	224
		8-3 Mini	8	64
		6-3.75 Large	28	168



Square Rack Inventory Systems
MVE Stock Series
Maximum Capacities
 Vapor Phase Storage with Vapor Platform

Freezer Model	Storage Phase	Description	Number of Racks	Number of Boxes
MVE 808	Liquid	9-2 Large	12	108
		9-2 Mini	4	36
		6-3 Large	12	72
		6-3 Mini	4	24
		5-3.75 Large	12	60
		5-3.75 Mini	4	20
	Vapor	7-2 Large	12	84
		7-2 Mini	4	28
		5-3 Large	12	60
		5-3 Mini	4	20
MVE 816P-2T-190	Liquid / Vapor	4-3.75 Large	12	48
		4-3.75 Mini	4	16
MVE 1318	Liquid	5-2 Large	21	105
		3-3.75 Large	21	63
		8-2 Large	24	192
		8-2 Mini	8	64
		5-3 Large	24	120
		5-3 Mini	8	40
	Vapor	4-3.75 Large	24	96
		4-3.75 Mini	8	32
		5-2 Large	24	120
		5-2 mini	8	40
		4-3 Large	24	96
		4-3 Mini	8	32
MVE 1842P-150	Liquid / Vapor	3-3.75 Large	24	72
		5-2 Large	54	270
		4-3 Large	54	216
		4-3 Mini	12	48
MVE 1877P-2T-150	Liquid / Vapor	3-3.75 Large	54	162
		5-2 Large	99	495
		3-3.75 Large	99	297



MVE Blood Bag Cassettes and Frames

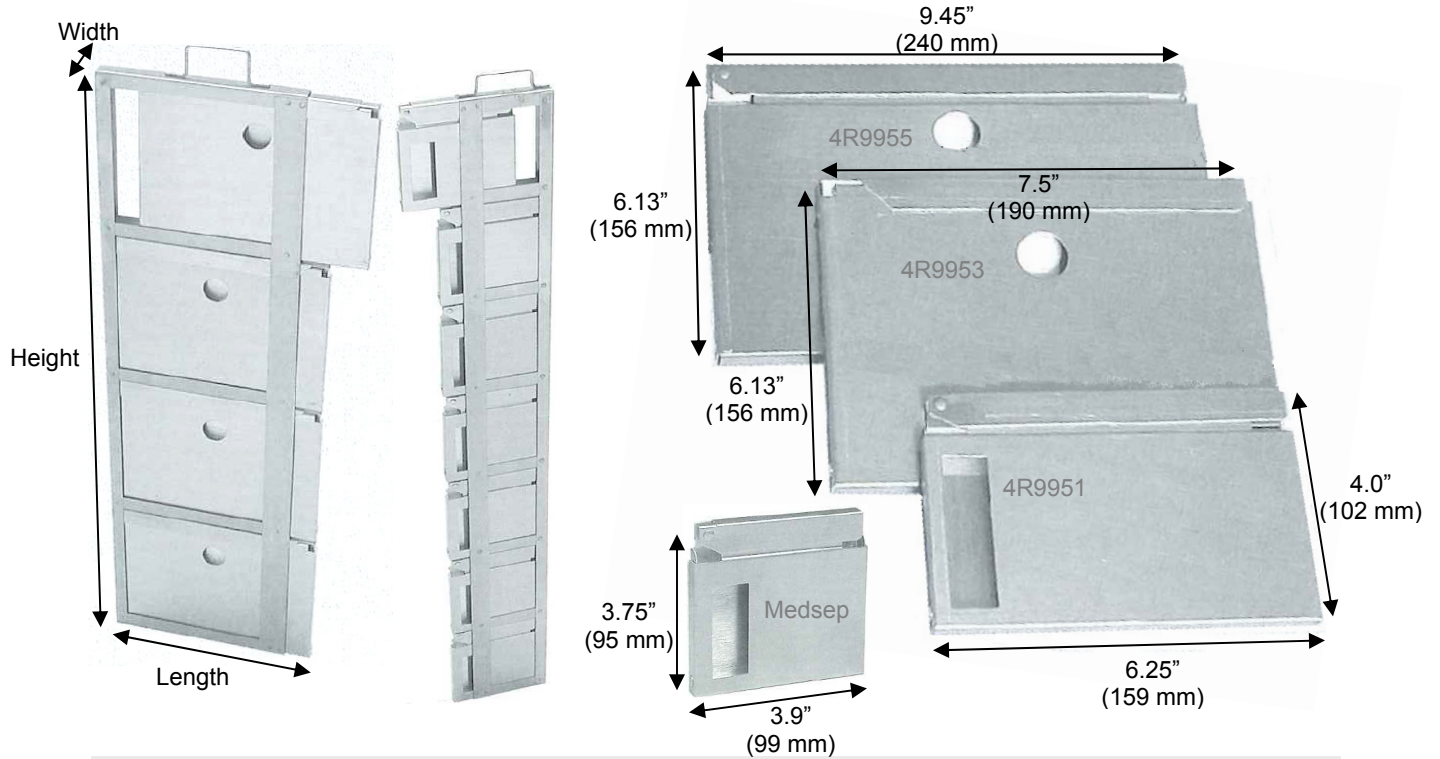

Medsep (791 OS/U) – 25 mL		
Description	PN	Dimensions L x W x H Inches (mm)
Cassette	11856322	3.9 x 0.45 x 3.75 (99 x 11 x 95)
6-Place Frame	11877158	4.0 x 0.6 x 23.0 (102 x 15 x 584)
7-Place Frame	11044623	4.0 x 0.6 x 27.0 (102 x 15 x 686)
8-Place Frame	11856314	4.0 x 0.6 x 31.0 (102 x 15 x 787)

4R9951 – 50 mL		
Description	PN	Dimensions L x W x H Inches (mm)
Cassette	10823393	6.25 x 0.45 x 4.0 (159 x 11 x 102)
6-Place Frame	10823385	6.45 x 0.6 x 25.5 (164 x 15 x 648)
7-Place Frame	11831951	6.45 x 0.6 x 29.5 (164 x 15 x 750)
8-Place Frame	11831969	6.45 x 0.6 x 33.5 (164 x 15 x 851)

4R9953 – 250 mL		
Description	PN	Dimensions L x W x H Inches (mm)
Cassette	10580694	7.5 x 0.45 x 6.13 (190 x 11 x 156)
4-Place Frame	10580740	7.6 x 0.6 x 26.0 (193 x 15 x 660)
5-Place Frame	10968111	7.6 x 0.6 x 32.5 (193 x 15 x 825)
6-Place Frame	11550905	7.6 x 0.6 x 39.0 (193 x 15 x 990)

4R9955 – 500 mL		
Description	PN	Dimensions L x W x H Inches (mm)
Cassette	10580707	9.45 x 0.45 x 6.13 (240 x 11 x 156)
4-Place Frame	10580766	9.65 x 0.6 x 26.0 (245 x 15 x 660)
5-Place Frame	10968437	9.65 x 0.6 x 32.5 (245 x 15 x 825)

DF 200 – 200 mL		
Description	PN	Dimensions L x W x H Inches (mm)
Cassette	10580715	8.0 x 0.75 x 6.13 (203 x 19 x 156)
3-Place Frame	10580791	8.15 x 0.9 x 19.8 (207 x 23 x 503)
4-Place Frame	10580782	8.15 x 0.9 x 26.0 (207 x 23 x 660)
5-Place Frame	10969149	8.15 x 0.9 x 32.2 (207 x 23 x 818)

DF 700 – 700 mL		
Description	PN	Dimensions L x W x H Inches (mm)
Cassette	10580723	12.75 x 0.75 x 6.13 (324 x 19 x 156)
3-Place Frame	10580811	12.9 x 0.9 x 19.8 (328 x 23 x 503)
4-Place Frame	10580803	12.9 x 0.9 x 26.0 (328 x 23 x 660)
5-Place Frame	10823115	12.9 x 0.9 x 32.2 (328 x 23 x 818)

All blood bag frames are 24 gauge, stainless steel
Overall frame length includes blood bag cassette

Blood Bag Inventory Systems MVE High Efficiency Series (-150 / -190)

Maximum Capacities

Freezer Model	Blood Bag	Number of Frames	Number of Stages	Number of Cassettes
MVE 815P	Medsep – 25 mL	204	6	1224
	4R9951 – 50 mL	128	6	768
	4R9953 – 250 mL	104	4	416
	4R9955 – 500 mL	76	4	304
	DF200 – 200 mL	59	4	236
MVE 818P	Medsep – 25 mL	204	8	1632
	4R9951 – 50 mL	128	7	896
	4R9953 – 250 mL	104	4	416
	4R9955 – 500 mL	76	4	304
	DF200 – 200 mL	59	4	236
MVE 819P	Medsep – 25 mL	204	8	1632
	4R9951 – 50 mL	128	8	1024
	4R9953 – 250 mL	104	5	520
	4R9955 – 500 mL	76	5	380
	DF200 – 200 mL	59	5	295
MVE 1536P	Medsep – 25 mL	440	7	3080
	4R9951 – 50 mL	248	6	1488
	4R9953 – 250 mL	203	4	812
	4R9955 – 500 mL	152	4	608
	DF200 – 200 mL	124	4	496
	DF700 – 700 mL	64	4	256
MVE 1539P	Medsep – 25 mL	440	8	3520
	4R9951 – 50 mL	248	7	1736
	4R9953 – 250 mL	203	4	812
	4R9955 – 500 mL	152	4	608
	DF200 – 200 mL	124	4	496
	DF700 – 700 mL	64	4	256
MVE 1879P	Medsep – 25 mL	838	7	5866
	4R9951 – 50 mL	492	6	2952
	4R9953 – 250 mL	396	4	1584
	4R9955 – 500 mL	276	4	1104
	DF200 – 200 mL	240	4	960
	DF700 – 700 mL	126	4	504
MVE 1892P	Medsep – 25 mL	838	8	6704
	4R9951 – 50 mL	492	8	3936
	4R9953 – 250 mL	396	5	1980
	4R9955 – 500 mL	276	5	1380
	DF200 – 200 mL	240	5	1200
	DF700 – 700 mL	126	5	630
MVE 1539R	Medsep – 25 mL	398	7	2786
	4R9951 – 50 mL	241	6	1446
	4R9953 – 250 mL	192	4	768
	4R9955 – 500 mL	144	4	576
	DF200 – 200 mL	122	4	488
	DF700 – 700 mL	66	4	264
MVE 1542R	Medsep – 25 mL	398	8	3184
	4R9951 – 50 mL	241	7	1687
	4R9953 – 250 mL	192	4	768
	4R9955 – 500 mL	144	4	576
	DF200 – 200 mL	122	4	488
	DF700 – 700 mL	66	4	264
MVE 1881R	Medsep – 25 mL	804	7	5628
	4R9951 – 50 mL	490	6	2940
	4R9953 – 250 mL	402	4	1608
	4R9955 – 500 mL	310	4	1240
	DF200 – 200 mL	246	4	984
	DF700 – 700 mL	136	4	544
MVE 1894R	Medsep – 25 mL	804	8	6432
	4R9951 – 50 mL	490	8	3920
	4R9953 – 250 mL	402	5	2010
	4R9955 – 500 mL	310	5	1550
	DF200 – 200 mL	246	5	1230
	DF700 – 700 mL	136	5	680



Blood Bag Inventory Systems
MVE Series / MVE Stock Series
 Maximum Capacities

Freezer Model	Blood Bag	Number of Frames	Number of Stages	Number of Cassettes	Divider Part Number
MVE 205	Medsep – 25 mL	77	7	539	11794176
	4R9951 – 50 mL	38	6	228	11794176
	4R9953 – 250 mL	32	4	128	n/a
	4R9955 – 500 mL	24	4	96	n/a
	DF200 – 200 mL	20	4	80	n/a
	DF700 – 700 mL	10	4	40	n/a
MVE 510	Medsep – 25 mL	126	7	882	10580918
	4R9951 – 50 mL	70	6	420	10823377
	4R9953 – 250 mL	56	4	224	10580897
	4R9955 – 500 mL	40	4	160	10580900
	DF200 – 200 mL	32	4	160	10580918
	DF700 – 700 mL	17	4	68	10580926
MVE 616/616C	Medsep – 25 mL	196	7	1372	11742704
	4R9951 – 50 mL	102	6	612	11742675
	4R9953 – 250 mL	84	4	336	11742683
	4R9955 – 500 mL	62	4	248	11742691
	DF200 – 200 mL	50	4	200	11742704
	DF700 – 700 mL	29	4	116	11742712
MVE 1426/1426C	4R9951 – 50 mL	154	6	924	10857964
	4R9953 – 250 mL	128	4	512	10580993
	4R9955 – 500 mL	106	4	424	10581005
	DF200 – 200 mL	84	4	336	10581013
	DF700 – 700 mL	42	4	168	10581021
MVE 1839	Medsep – 25 mL	496	8	3968	10581110
	4R9951 – 50 mL	232	8	1856	10878440
	4R9953 – 250 mL	202	5	1010	10581099
	4R9955 – 500 mL	154	5	770	10581101
	DF200 – 200 mL	122	7	854	10581110
	DF700 – 700 mL	76	7	532	10581128
MVE 808	4R9953 – 250 mL	80	3	240	10580942
	4R9955 – 500 mL	62	3	186	10580951
	DF200 – 200 mL	48	3	144	10580969
	DF700 – 700 mL	29	3	87	10580977
MVE 1318	4R9953 – 250 mL	164	3	492	10581048
	4R9955 – 500 mL	132	3	396	10581056
	DF200 – 200 mL	106	3	318	10581064
	DF700 – 700 mL	62	3	186	10581072

